

**Art.Nr. 9071**  
**Krebsöge Wasserturm**

**Vor Baubeginn bitte lesen !**

**Zusammenbau:**

Benutzen Sie beigefügte Stückliste, um die Bauteile zu identifizieren und schneiden Sie die Teile an den Rahmenaufhängungen aus. Bauteile mit Knicklinien bitte nur vorsichtig knicken ( evtl. um die Tischkante knicken ).

Verwenden Sie für diesen Architektur-Bausatz bitte nur hochwertigen Weißleim ( Holzleim ). Es hat sich bewährt, den Klebstoff mit einem Zahnstocher aufzutragen. Verkleben Sie die Teile nicht flächig, sondern nur punktuell.

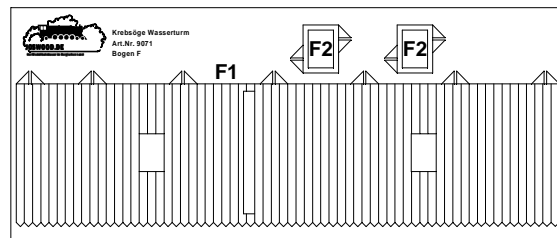
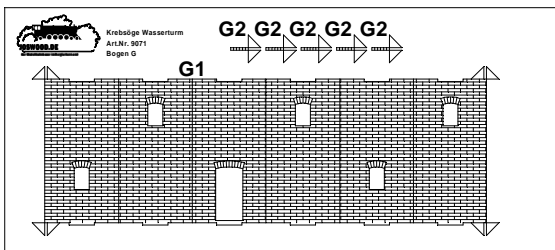
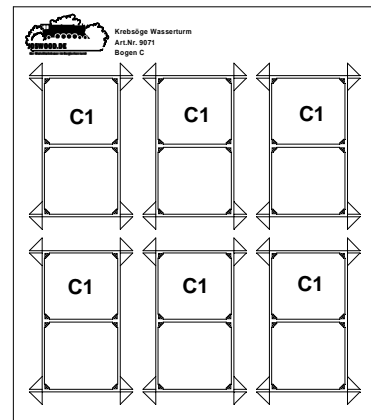
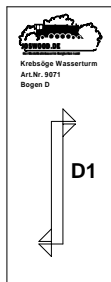
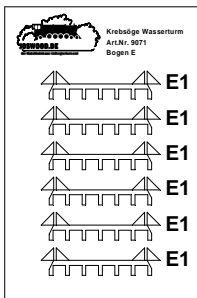
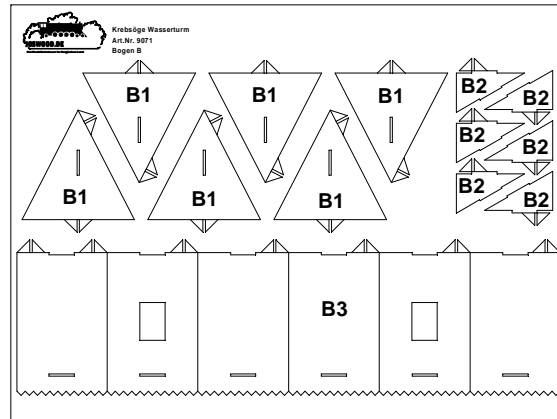
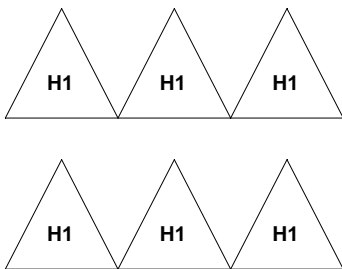
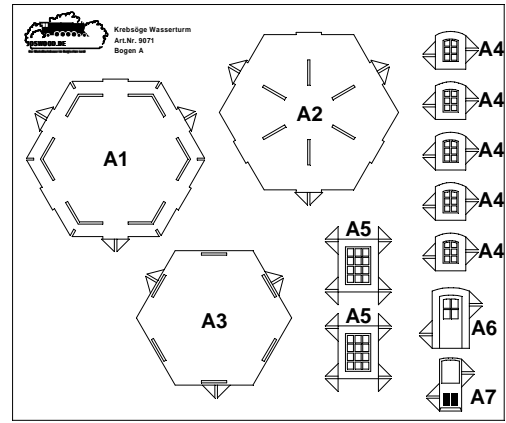

**Art.Nr. 9071**  
**Krebsöge Wasserturm**

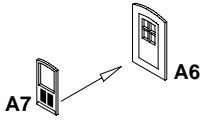

**Schritt 1**

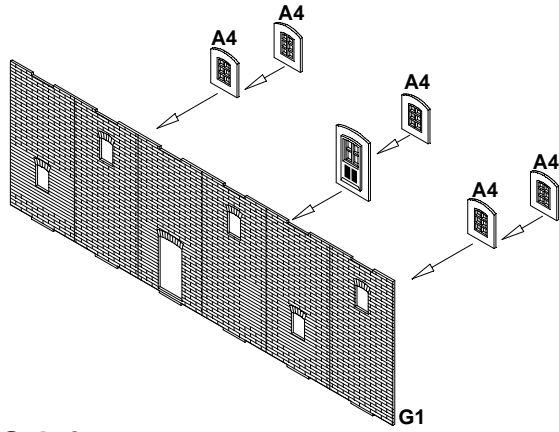

**Schritt 2**

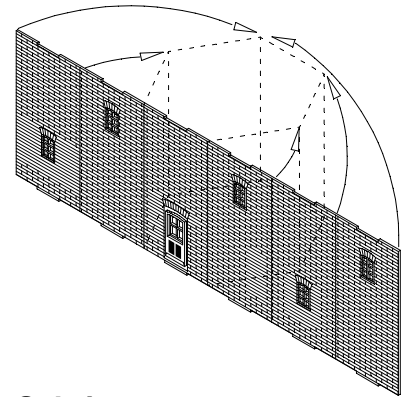

**Schritt 3**

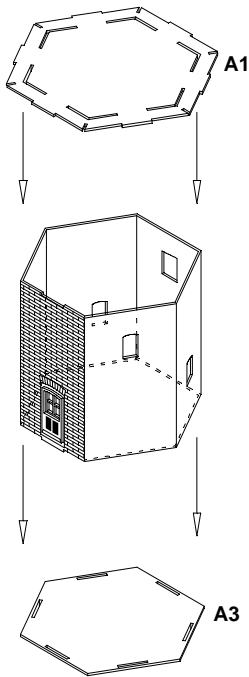

**Schritt 4**

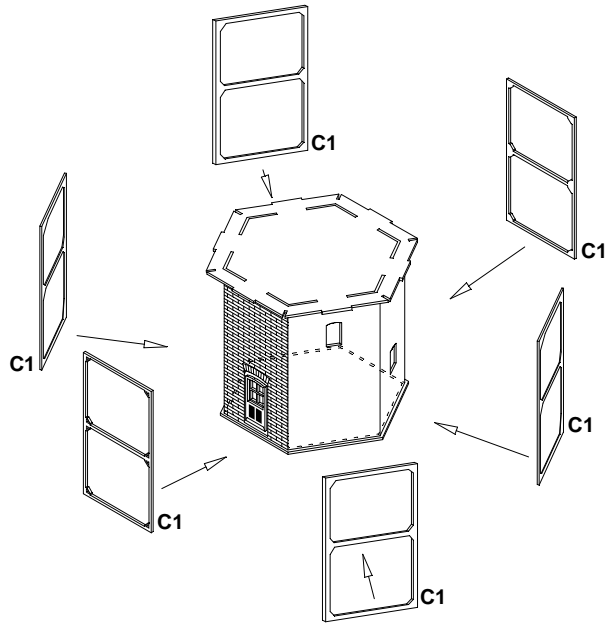

**Schritt 5**

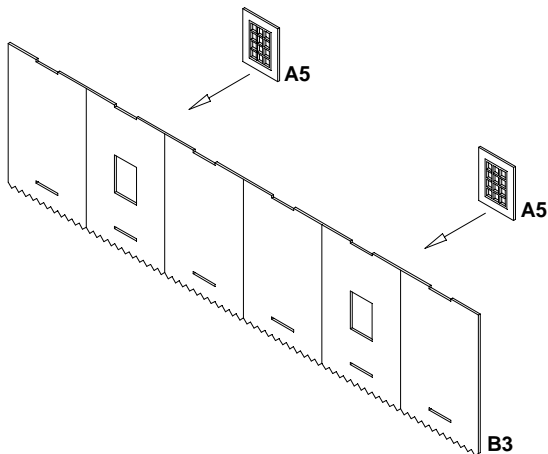

**Schritt 6**

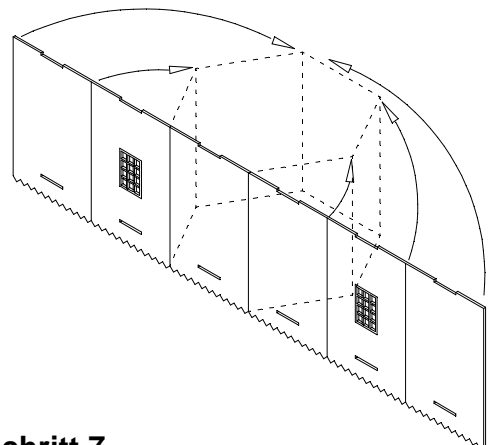

**Schritt 7**

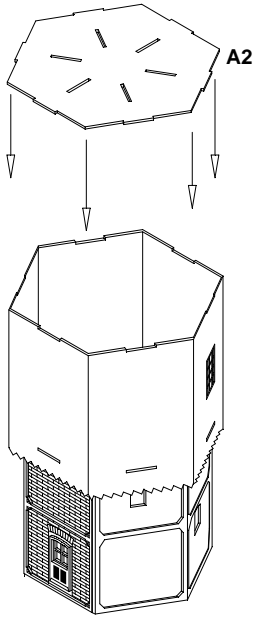

**Schritt 8**

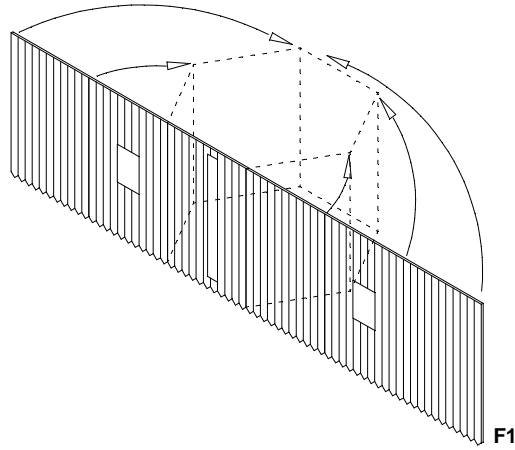

**Schritt 9**

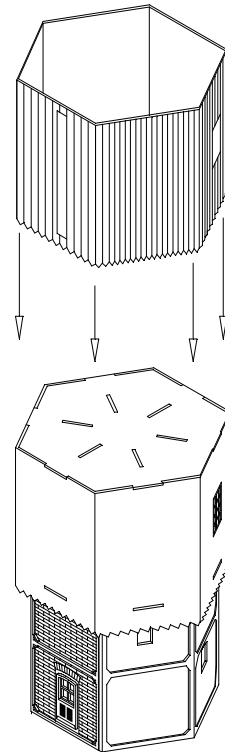

**Schritt 10**

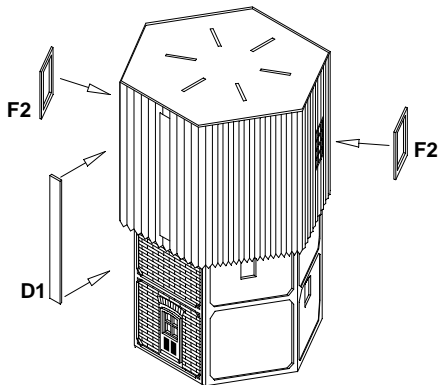

**Schritt 11**

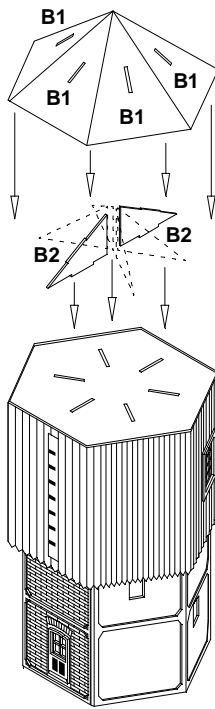

**Schritt 12**

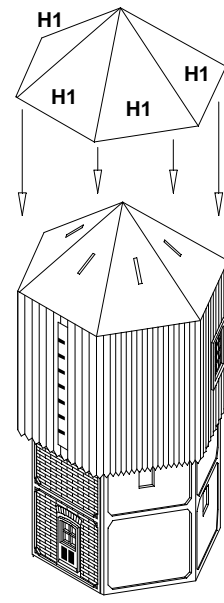

**Schritt 13**